

@
S683

161

Cornell University Library
S 683.I61

Tractor plowing at its best ...



3 1924 003 310 962 mann

TRACTOR
PLOWING

at

ITS BEST

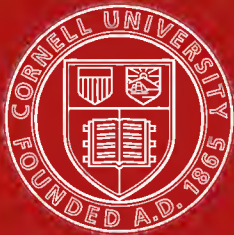

Cornell University Library

The original of this book is in
the Cornell University Library.

There are no known copyright restrictions in
the United States on the use of the text.

Tractor Plowing

at

Its Best

[Illustrated]



INTERNATIONAL HARVESTER COMPANY
OF AMERICA
(INCORPORATED)

606 SO. MICHIGAN AVE.

CHICAGO, ILL.

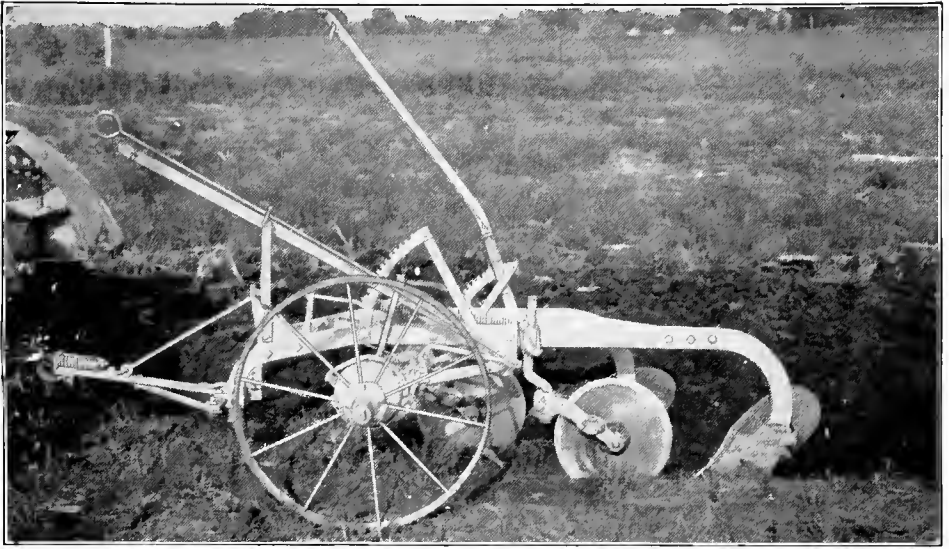

Illust. 1. This plow is set for one hundred per cent perfect work. Both bottoms will turn furrows exactly the same width and depth. The hitch is at the correct angle, neither too high nor too low, and a minimum amount of power will be required to pull the plow. To obtain this result the adjustments noted in the following pages are required.

Preliminary Adjustments

Rolling Coulter

The purpose of the rolling coulter is to furnish a thin, sharp edge which will cut trash, roots and tough soil with a minimum amount of power. While under usual conditions a plow will do nearly as good work without the coulter as with it, it will require more power because the shin of the mold has a tearing rather than a cutting action.

The position of the rolling coulter with relation to the plow bottom has a great deal to do with the quality and appearance of the work. In most cases the center of the coulter should be directly above the point of the plow, as shown in the illustration on this page. The proper height for the coulter depends upon the depth of the plow and the nature or

condition of the soil. In this illustration (No. 2) the coulter is shown set for plowing about six inches deep in ordinary soils. Notice that the lower edge of the coulter is about an inch and a half above the point of the share.



Illust. 2

For deep plowing, the rolling couler should be raised. It should not run more than about three and one-half inches deep. The position shown in Illust. 4 is about right for plowing eight or nine inches deep. Notice that as the couler is raised it should also be moved slightly to the rear, giving the share a better chance to penetrate the soil. If the ground is exceptionally hard the couler has a tendency to ride the plow out of the ground when set too far ahead. When a plow doesn't take to hard ground



Illust. 4

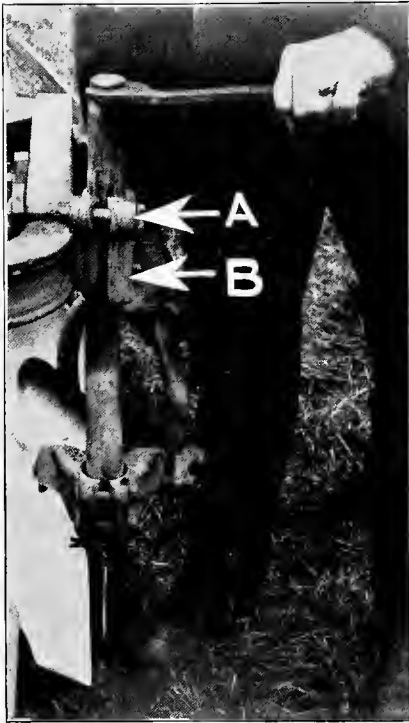

Illust. 3

as it should, see if the coulters are too far forward or set too deep. For hard ground center of couler should set about 3 inches back of point of share.

The position of the rolling couler with relation to the landside has much to do with the quality of the work, especially with the neatness of the furrow bank. Under most conditions, the couler should be set $\frac{1}{2}$ to $\frac{3}{4}$ of an inch to the left of the landside, as shown in Illust. 3. It can be moved to right or left by loosening nuts A and B and turning standard with a large wrench as shown. Setting couler out prevents edge of furrow from crumbling and preserves a better furrow bank.

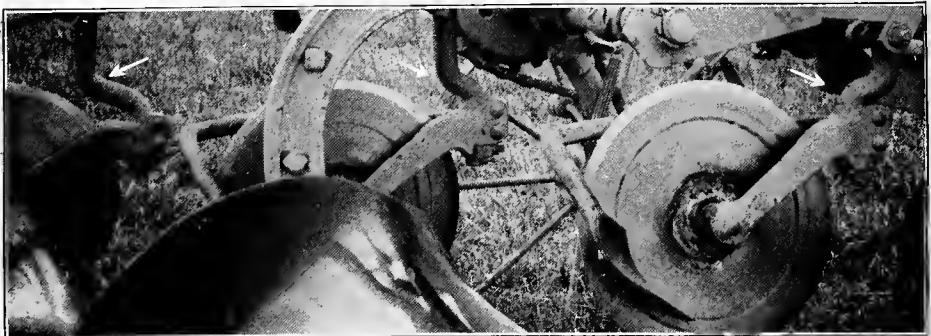

Illust. 5. When the coulters are properly set, they will line up as shown above. Notice the angle at which the offsets in the couler shanks set—front one toward the rear and the second and third toward the front.

Opening A "Land"

Illustration 6 shows the opening up of a new land with the last plow running between six and seven inches deep, and the first one three to four inches deep. This setting will prevent a high ridge even though it is desired on the return trip to have the first plow throw back the opening furrow.

When opening a land, the right hand or furrow wheel must necessarily be set higher than is the case after the first round has been made and this wheel is running in the furrow. The two levers shown in Illust. 7 are used to adjust the depth and to level the plow. To open a land, the levers should be about in the positions shown. After the first time around, the plow should be leveled with the furrow wheel in the furrow, and after that the levers should require practically no attention until the land



Illust. 6

is finished. Of course if there are tough spots, or grades, where the draft is exceedingly heavy, it may be necessary to run the plow somewhat shallower.



Illust. 7

On the Nos. 3, 4, 5, and 7 Little Genius plows these two levers can be operated independently of the power-lift device. This feature has the advantage that should one of the bottoms encounter a stone or root, the plow can be backed and the bottoms raised by hand. The same thing can be accomplished on No. 8 Little Genius by backing the plow a short distance and raising the bottoms with the power lift. This permits the removal of the obstacle, and the plowing can then proceed without leaving a skip.



Illust. 8. Showing proper hitch for 2-bottom plow

Hitch

One of the commonest sources of excessive draft is the hitch between the plow and the tractor. The drawbar of the plow should make, as nearly as possible, a straight line between the tractor drawbar and the center of the load on the bottoms. If the hitch slopes downward from the plow to the tractor, unnecessary weight is thrown on the front wheels, increasing the draft, and wearing out the wheel bearings. The line of hitch should slant slightly upward toward the tractor.

McCormick-Deering tractor plow hitches are now assembled for hitching to the center of McCormick-Deering 10-20 and 15-30 tractors. Since the center of draft in a two-bottom plow is approximately 17 to 19 inches from the furrow wall, the center hitch is ideal under average plowing conditions. In the case of the three-bottom plow the center of draft is approximately 24 to 26 inches from the furrow wall, and hitching to the center of the McCormick-Deering 15-30 tractor is correct under average plowing conditions. Note that the right hand tractor drive wheel runs in the furrow.

In hard plowing the center of draft has a tendency to move to the right, closer to the centers of the bottoms, owing to the heavier mold-board pressures. To overcome excessive land-side pressure under these conditions, set the plow hitch to the right. In very shallow or very loose plowing the land-sides may have a tendency to run away from the furrow wall. To overcome this tendency, and steady the plow, adjust the plow hitch to the left. Under extreme conditions it may be desirable to hitch to right or left on the tractor drawbar.

In hillside plowing it is often desirable to hitch the plow farther to the right when throwing the furrow up-



Illust. 9

hill than when going the opposite way. Where the hills are so steep as to make frequent hitch adjustment necessary it is recommended that the plowman use the special adjustable drawbar hitch, which has a lever which enables the plowman to adjust the hitch instantly.

Spring Tension

The weight of the bottoms should be evenly counterbalanced by the heavy tension springs in order to make them lift as easily as possible, either by the operator or the power-lift mechanism. It is easy to adjust the tension of these springs. If the plows raise too hard, loosen the lock nuts (Illust. 10) on the adjusting bolts at the ends of the springs and tighten the second nut until the proper tension is obtained as shown above. Spring A adjusts the lifting tension on the axle of the front furrow wheel, which is operated by hand lever C. Spring B adjusts the lifting tension of the axle on the land wheel, which is operated by hand lever D.

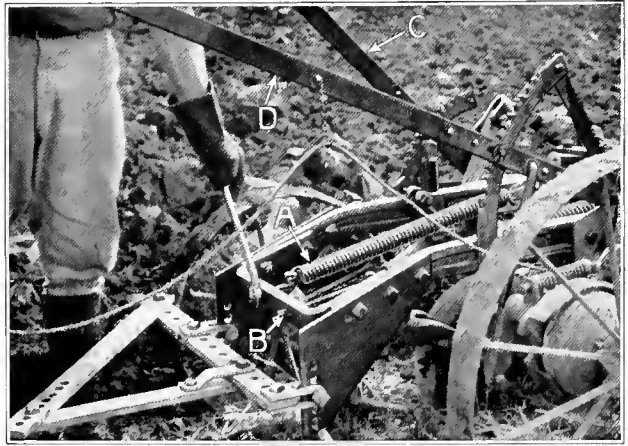

Illust. 10

When the tension of these springs is properly adjusted, the springs will assist the lift in raising the bottoms and will not in any way retard lowering.

With plows that depend entirely on the weight of the bottoms to get the bottoms into the ground, too much tension on the springs may interfere with penetration.

The Rear Wheel

The heel of the third plow should run lightly both against the bottom and the wall of the furrow. It should not carry the full downward pressure from the weight of the rear end of the plow nor the full side pressure from the furrow.

It is easy to ascertain whether the heel is bearing against the furrow bank or bottom by observing whether it is leaving grooves and, if so, how deep such grooves are.

The heel of the plow can be raised or lowered by means of the set-screw shown in Illust. 11. To make the adjustment, first loosen lock-nut and clamp bolt, then turn the set screw in to raise heel or out to lower it.



Illust. 11

The rear furrow wheel should run in the corner of the furrow, and be so adjusted that it bears a part of the weight of the rear end of the plow, as well as a part of the side pressure against the furrow wall. Also, this wheel should have a lead of $\frac{1}{4}$ to $\frac{3}{8}$ inch to the right. By "lead" we mean that the edge of the tire should be farther from the furrow wall in front than in the rear. This will lighten the pressure on the landside. If the furrow wheel does not stand in proper relation to the landside, that is, does not lead away from the bank, it should be changed. How to do this on the No. 8 Little Genius is shown in Illust. 13.

It is essential to good plowing that the heel of the rear landside bear lightly on the bottom of the furrow.

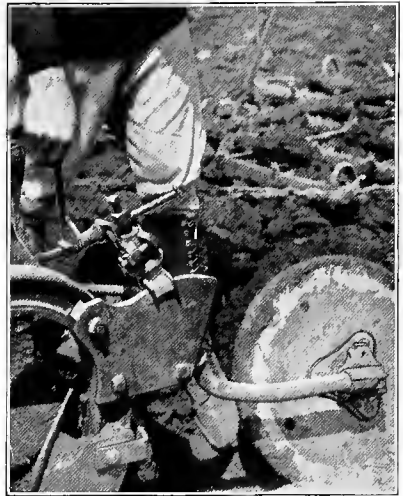

Illust. 13

the wheel is run against furrow wall, a slight deviation of the tractor from the furrow wall causes wheel to climb bank or cut against it in such a way as to interfere with the work. The wheel is run away from the bank to provide against slight deviations of the tractor.



Illust. 12

The Front Wheel

The notion prevails in many sections that the front furrow wheel should run against the bank of the furrow. This is wrong. The inner edge of tire should be about two inches from bank, as shown in Illust. 12. In this position the first plow will cut the same width as the others. If wheel is run against bank the front bottom will cut two inches more than it should, throwing additional draft on tractor and resulting in an inferior job of plowing. Also, if

The Jointer

When difficulty is experienced in covering trash, it is advisable to use a jointer. It is important that the jointer be properly adjusted. When used in connection with a rolling coulter as illustrated, its point should be set as close as possible to the face of the coulter without actually running against it. Proper adjustment is easily obtained by means of the two nuts, A and B.



Illust. 14

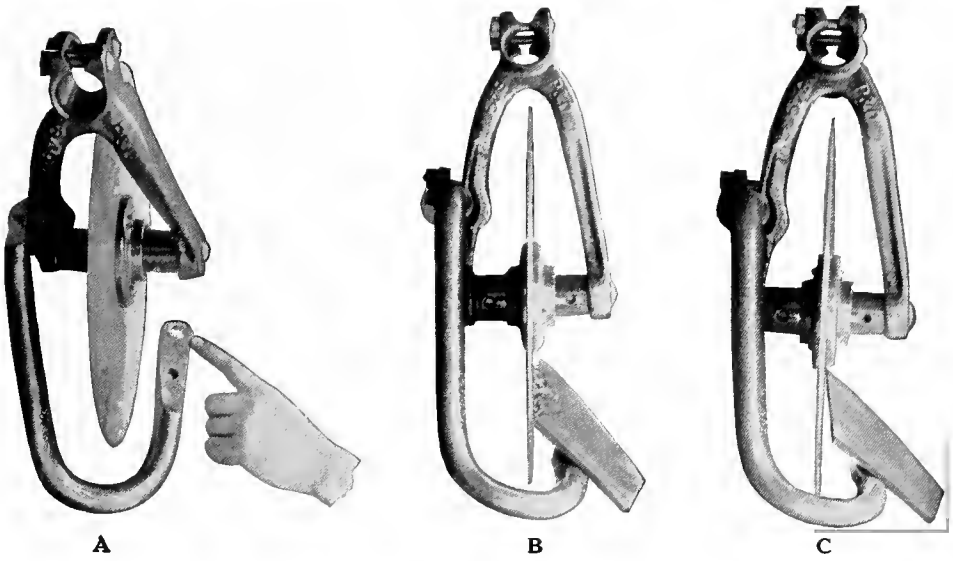

Illust. 15

and by the slotted hole in the end of the jointer as shown in Illust. 14. Loosening nut A slightly and tightening nut B will move the jointer away from the couler. To move it toward the couler, reverse the operation.

A simple but very important adjustment is provided for in the slotted hole at the end of the jointer shank as shown in A, Illust. 15. This slot permits moving the point of the jointer toward or away from the couler. The jointer should always be adjusted as shown in C, with the point close to the couler and with the space between the jointer and couler widening toward the rear. This prevents weeds or trash from wedging between the couler and jointer, as will happen if the point is farther from the couler than the rear of the blade. B shows the wrong adjustment, with trash wedged between the couler and jointer blade. By loosening the two bolts which

hold the blade to the shank, it is easy to get the right adjustment as shown in C. The rear of the edge next to the couler should be about three-eighths of an inch from the couler, while the point should be as close as possible without causing friction.

The use of the jointer alone has been largely discontinued, as in most cases the combined couler and jointer does so much better work.

Illust. 16 shows the proper position of the jointer in relation to the shin of the plow, namely about one-half inch to the left. The jointer is moved to the right or left as shown in Illust. 17.

The heel of the jointer share should run a little above the top of the ground. This will make it cut a cleaner furrow and will prevent it from becoming fouled with trash. The line A-B (in Illust. 16) shows about the depth the jointer should cut.



Illust. 16



Illust. 17

It is a simple matter to adjust the position of the jointer with relation to the shin of the plow. In order to move the jointer farther to the left, loosen



Illust. 18

nut A (Illust. 17) slightly, and tighten nut B. In order to move it to the right, reverse the operation.

To adjust the pitch of the jointer with reference to the point of the share, that is, to move it forward or back, the set screw shown in Illust. 19 is turned to the right or left, as the case may be. Do not attempt to change the position of the jointer by means of the set screw when the two bolts which hold the jointer to the plow beam are tight. Slightly loosen the nuts on the two bolts which hold it in place, then turn the set screw until the jointer is in its proper position, then tighten the nuts. The set screw only changes the pitch of the jointer.



Illust. 19

The rolling coultter yoke permits a slight turning movement, either to the right or left. Since this joint is in a position where it comes in contact with a great deal of dust and grit, more or less wear is likely to occur. There should not be unnecessary looseness at this joint as two bolts, A and B (Illust. 18), are provided for taking up wear.

Shares

It does not pay to plow with dull or worn-out shares. It is always desirable to have at least one complete set of spare shares (two sets are better) so that one set may be used while the other is being sharpened. Practically all tractor plows are now equipped with quick-detachable shares. It requires but a moment to unscrew the nut A far enough so that the front end of the bolt slips over the head of the bolt on the share. One turn on the nut B on the wing of the share and the share slips off, after which a new one can be slipped into place, and the nuts tightened.

A new share is made with what is called suction, that is, it is made with the point of the share pointing slightly downward. This is done to make the share penetrate readily. As the point wears off, this suction is gradually lost and difficulty will be experienced in getting the bottoms to take to the ground. To repeat, it does not pay to use dull shares. It costs more in fuel, time, and patience than the cost of resharpening justifies. (See page 20.)

Rear Wheel Scraper

Where the soil is sticky, the rim of the rear furrow wheel is quite likely to become caked with mud, thus increasing the diameter of the wheel and changing the adjustment of the plow. In order to prevent the ac-

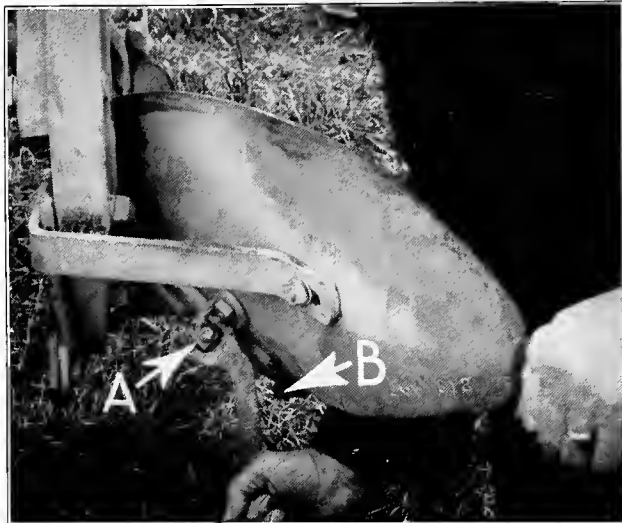

Illust. 21



Illust. 22



Illust. 20

cumulation of mud on the rim and to keep the diameter of the wheel uniform, the wheel scraper should be adjusted so that the point is at the center of the wheel rim and about one-fourth of an inch from its surface.

On a plow whose furrow axle is held against side play by collars, as shown in Illust. 20, the collars must be kept tight on the axle—there should be no side play at the points indicated by the arrows.

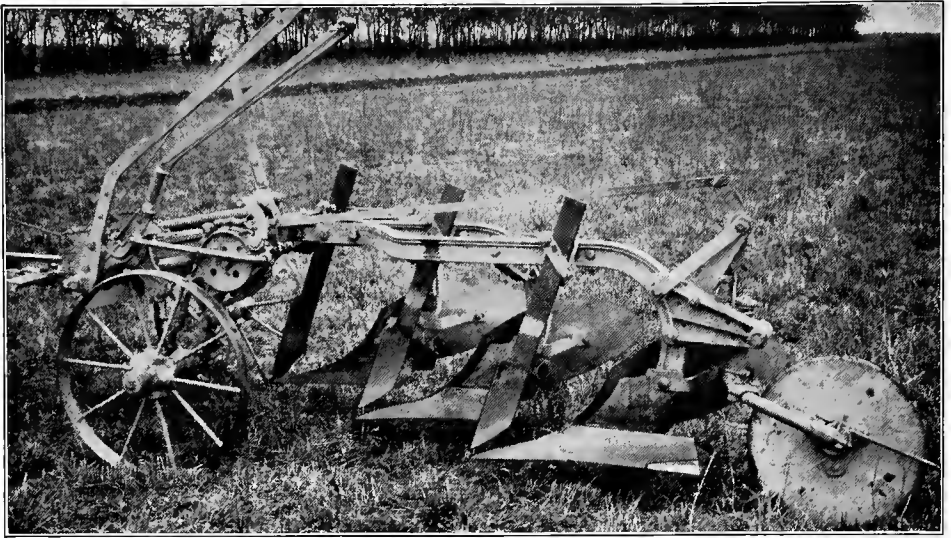

Illust. 23

Hanging Cutter

Under some conditions the use of the hanging cutters is desired. The proper position for these under most conditions is as shown in the Illust. 23, with their points about one inch above the points of the shares and with the cutters slanted backward at a slight angle.

The position of the hanging cutters with relation to the points is shown in Illusts. Nos. 24 and 25.

Illust. 24 shows the proper position of the hanging cutter with relation to the point of the plow, namely about one-half inch to the left and with the left-hand side of the cutter parallel with the landside of the plow. The adjustment of the cutter from side to side is shown in Illust. 25.

Illust. 25 shows how the position of the hanging cutter can be changed with relation to the point of the plow. By loosening nut A and tightening nut B the edge of the cutter is moved toward the left.

To move it toward the right the operation is reversed.



Illust. 24



Illust. 25

Oiling

It is a mistake to assume, because a plow moves slowly and has few moving parts, that oil and grease are not necessary. The bearings on tractor plows work under severe conditions. Grit causes wear and no plow can do first-class work when its wheel bearings are



Illust. 26

worn and wobbly. When there is plenty of oil in the bearings, dust cannot get in, for as the oil works out it carries the dust with it. McCormick-Deering



Illust. 27

tractor plows are now being equipped with oilers of the Zerk or Alemite type at points where frequent oiling is necessary.

The three wheel hubs are provided with screw caps designed to be used as grease cups. Fill these frequently and force the grease into the bearing. At



Illust. 28

the beginning of the season it is well to squeeze in several capfuls.

While the wheels are equipped with hard oil screw caps, which force the grease back into the bearing, the grease is very likely to work away from the sand bands. A covered oil hole is provided on the sand bands and these should receive frequent oiling.



Illust. 29

Keep the coulter bearings oiled—the coulter can't do first-class work when the bearings are worn.

The rear wheel (Illust. 29) sets at an angle, with the wheel box pointing downward. This means that the grease would naturally work away from the sand band, and frequent oiling will prevent friction at this point.

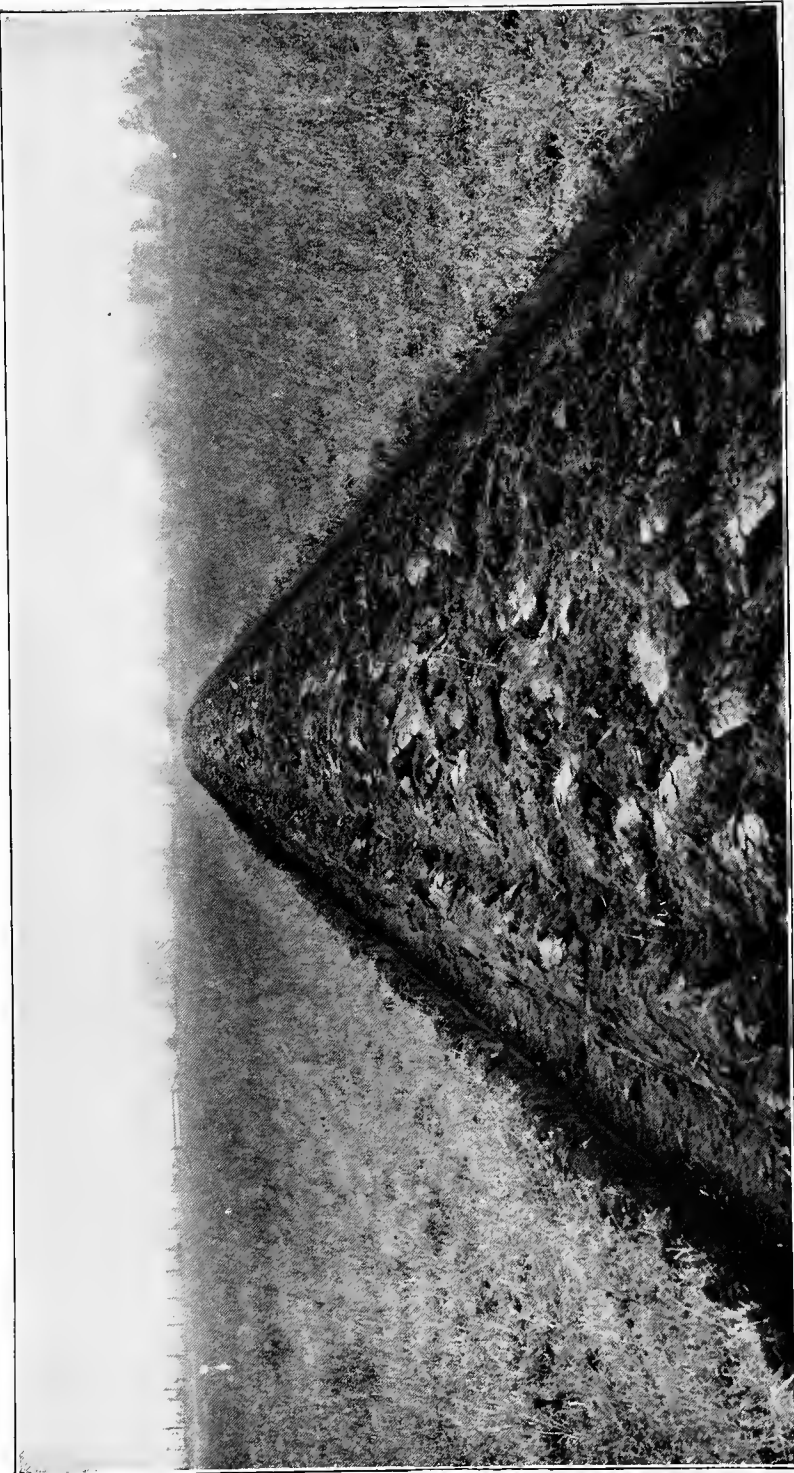

Illust. 30

A Good Job of Opening a Land

In this case, the shallow furrow strips turned by the first plow are right together, leaving a narrow strip of unplowed land beneath them. Note the ragged furrow bank on the left. This was caused by the rolling coulter not being set far enough to the left of the landside. The bank at the right was made after the coulter had been properly set. Note the smooth furrow wall and the absence of fresh dirt on the land.

Principles of Draft in Tractor Plows

The outstanding advantage of plowing with tractors is, of course, economy—maximum production per man. This is so well understood now that we shall not here go into that phase of the subject. Another advantage is the ability, with a tractor plowing unit, to get the plowing and tillage done in time for seasonable planting, which generally results in better crops, and greater yields. Not only is the hourly accomplishment of a tractor plow greater than that of a horse plow, but the tractor, unlike the horse, can be worked two or three shifts a day, and often is.

These, and other advantages, have been discussed so much that the quality of tractor plowing and the simplicity of using a tractor plow, as compared with horse plows, too frequently have been overlooked.

Tractor plowing has a uniformity of appearance, depth, and quality which can be achieved with horse plows only by very experienced plowmen. And the adjustments required to adapt a tractor plow to varying conditions are simpler and more quickly made. Stated from another angle, there are fewer chances for failure to do good work with a tractor plow than there are with a horse plow.

Yet there are conditions encountered in tractor plowing which call for some knowledge of the principles involved in plow design and operation, if the plow is to be given a chance to do its best work under all conditions. Not infrequently plows are condemned for poor work when the trouble arises entirely from wrong hitch or faulty adjustment of equipment.

The Center of Draft

While it is not necessary that the tractor plowman possess the information which is presented here, he will find it easier with this knowledge to do more nearly perfect work. Plowing must be done under an extremely

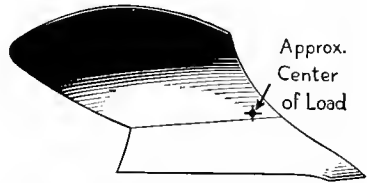

Illust. 31. The cross indicates the approximate location of the center of load on a plow bottom under average plowing conditions.

wide range of conditions. When tractor plows leave the factory they are set for average conditions. Naturally, some of them may need adjustment to meet special conditions on the farms they happen to reach.

One of the most frequent causes of failure to do good work is a wrong hitch. Nor does the damage caused by wrong hitch stop with the work. Nearly always there is also undue wear on the plow, and heavier draft, resulting in higher fuel cost per acre of plowing.

To be able intelligently to hitch a plow to a tractor it is an advantage to have an idea of the location of the center of load on the plow bottoms and its relation to the drawbar of the tractor, or, in plow parlance, the line of draft. If the center of load would stay in one place for all conditions, hitching would be greatly simplified, but it won't.

Most authorities agree that in a 14-inch bottom, under average conditions and at average depth, the center of load is 2 inches from the shin, and not far above the joint between the moldboard and share.

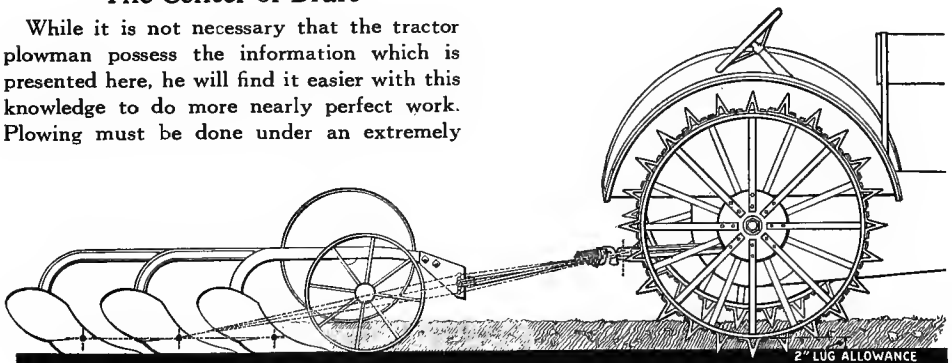

Illust. 32. Of the dotted lines the straight line shows the true line of draft with respect to the height of the plow hitch and the tractor drawbar. The other dotted lines show high and low hitch. The bent lines will straighten under load and the working of the plow will be affected accordingly.

Results of Too High Hitch

The line of draft is an imaginary line from the center of load on the bottoms to the point of hitch at the tractor drawbar. Regardless of how high or low we hitch, that line is going to do its best to straighten out. If we hitch too high on the plow, too much weight is carried by the front wheels of the plow. The result is worn wheel bearings, and a tendency of the bottoms to "stutter" or bob along on the noses of the shares.

Hitching too high is also likely to cause poor scouring. The reason for this is that when a bottom is tipped on its point, the angle of the bottom with reference to the furrow slice is changed—made more abrupt—the soil encounters the turning surface of the moldboard too squarely to push itself off. Also, the moldboard being too abrupt, that is, too straight up, the furrow slice breaks down before it should and passes under the wing of the board instead of turning over as it should. Perfectly good plow bottoms have been condemned for failure to scour, and for failure to turn the furrow, when the trouble was due entirely to a hitch too high on the plow.

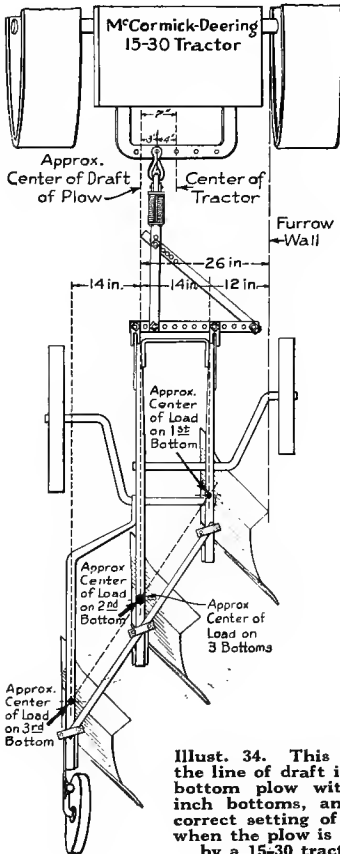

Illust. 34. This shows the line of draft in a 3-bottom plow with 14-inch bottoms, and the correct setting of hitch when the plow is pulled by a 15-30 tractor.

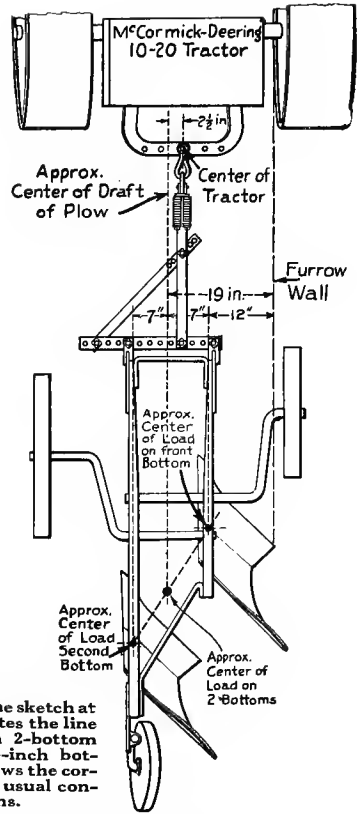

Illust. 33. The sketch at the right locates the line of draft in a 2-bottom plow with 14-inch bottoms, and shows the correct hitch for usual conditions.

If Hitch Is Too Low

Hitching too low on the plow has the opposite effect. Too much weight is thrown on the rear wheel, or on the bottom of the rear landside if there is no rear wheel, and the front wheels do not carry their portion of the weight. Resistances which should be converted to a rolling load must be overcome as friction, and again there is heavier draft.

The Tractor Drawbar

It is well to remember that lowering the tractor drawbar is equivalent to raising the hitch on the plow, and that raising the tractor drawbar is equivalent to lowering the hitch on the plow.

Lateral Hitch

Now we'll suppose we have plowed around once and that we have started on the second through and have the wall of a previously made furrow from which to measure. From this we shall locate the center of load for 2-, 3-, and 4-bottom plows, assuming that the plows are equipped with 14-inch bottoms.

The point 2 inches from the shin, the center of load on the first bottom, is 12 inches from the furrow wall. The center of load on the second bottom is 12 inches, plus 14 inches, or 26 inches from

the furrow wall. The center of load on the two bottoms is, therefore, half way between 12 and 26 inches, or 19 inches from the furrow wall. The center of load on a 3-bottom plow is the center of load of the middle bottom, which, as we have just shown, is 26 inches from the furrow wall. In other words, when we add a 14-inch bottom, the center of load of the gang shifts 7 inches farther from the furrow wall, or half the width of the bottom added. Add 7 inches to 26 inches and you have 33 inches for the center of load in a 4-bottom plow. The true line of draft is straight forward from the center of load. For plows with 12-inch bottoms the lines of draft are, from the furrow wall, 16 inches for the 2-bottom, 22 inches for the 3-bottom, and 28 inches for the 4-bottom.

Conditions Affecting Line of Draft

Keep in mind that these locations are based on the more or less arbitrary assumption that the center of load is 2 inches from the landside or furrow wall. Often it is farther to the right than that, and sometimes it is nearer the landside. For stubble plowing, the figures are very close. In hard plowing, or heavy sod, more pressure is thrown on the moldboards, and the center of load may shift considerably toward the centers of the bottoms. Conditions which might cause the center of load to shift toward the left are loose soil, shallow plowing, blunt shares, plowing in root-matted soil without rolling coulters, etc.

Better Than Guessing

While it is always possible to arrive at a fairly correct adjustment of a plow by trial, the plowman who knows about where the center of load is located in his plow and the relation of the true line of draft to the line of hitch, is able more quickly and intelligently to make the adjustments necessary to adapt his plow to the conditions under which it has to work. Horse plows are far more sensitive to side draft than tractor plows, yet it is helpful to know these things even in the operation of tractor plows.

Instruction books supplied with McCormick-Deering tractor plows show how to assemble the hitches for hitching to the centers of McCormick-Deering tractors. These hitches are correct for average conditions. By applying the principles outlined above, the user can recognize the effects caused by shifting of the true line of draft, due to unusual conditions, and adjust the hitch to meet them. If there is too much landside pressure, leading the rear wheel away from the furrow wall or hitching farther to the right on the tractor,

drawbar will hold the landside away and make the plow run lighter.

Hitching Too Far to Right

If the hitch is too far to the right on the plow when hitched to the center of the tractor, shifting the hitch four inches to the left on the plow and hitching in the first hole to the left of center on the tractor drawbar will favor the plow, while the effect on the tractor will be scarcely noticeable. We have shown the 3- and 4-furrow plows hitched this way because we believe such a hitch covers a wider range of plowing conditions. It should be noted that a tractor plow is not sensitive to slight off-side hitch under ordinary plowing conditions, and that, if the center of load on the plow does shift, the shift is usually in favor of the hitches

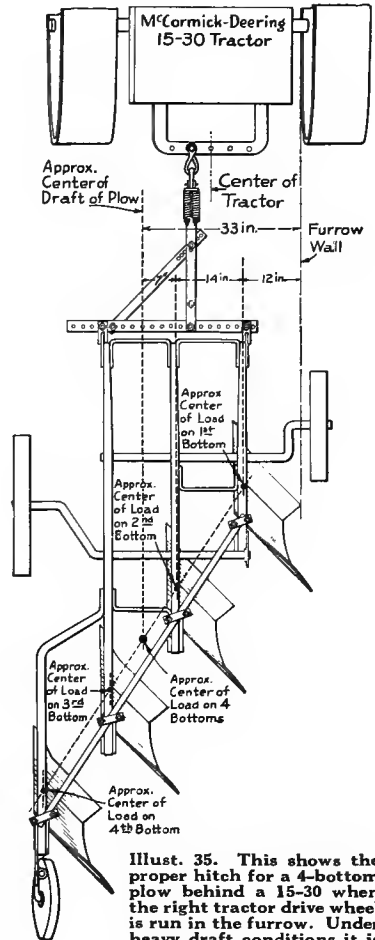

Illust. 35. This shows the proper hitch for a 4-bottom plow behind a 15-30 when the right tractor drive wheel is run in the furrow. Under heavy draft conditions it is sometimes desirable to run both tractor drive wheels on the land.

shown. That is, as the plowing gets harder, the center of load on the bottoms shifts closer to the line of hitch.

When Tractor Is Run On Land

Often when plowing in loose, crumbly, or marshy land, it is desirable to run the tractor on the land. When this is done it is customary to hitch in the first hole to the right of the center of the tractor drawbar, which is somewhat to the left of the center of draft of the plow. While we can't always hitch in the true line of draft, knowledge of where that line is helps the plowman to understand the action of his plow and to correct adjustments to meet conditions. More or less landside pressure results from running the tractor on the land, but it can be counteracted by leading the rear wheel (on three-wheel plows) away from the furrow wall.

The Front Furrow Wheel

Probably the best evidence of whether a plow is hitched right laterally is to observe the land wheel. If this wheel is running straight, it indicates proper lateral hitch.

If the plow is hitched so that the front bottom is cutting its correct width and the coulters are set right, the furrows all lie alike and there is a uniformity of appearance which cannot be duplicated by the average plowman with horses.

Soil On Wheels Affects Depth

If the soil packs on the rims of the tractor drive wheels, and on the plow wheels, the depth of plowing is affected, and the additional wheel diameter should be allowed for in the adjustment of the levers. Ridging the soil often results from failure to level the plow. The depth and leveling levers work together—the plowman should always be sure to use the leveling lever when he makes any appreciable change in the adjustment of the depth lever. The rear-wheel scraper should be adjusted to keep the wheel clean. One of the functions of the rear wheel on a three-wheel plow is to

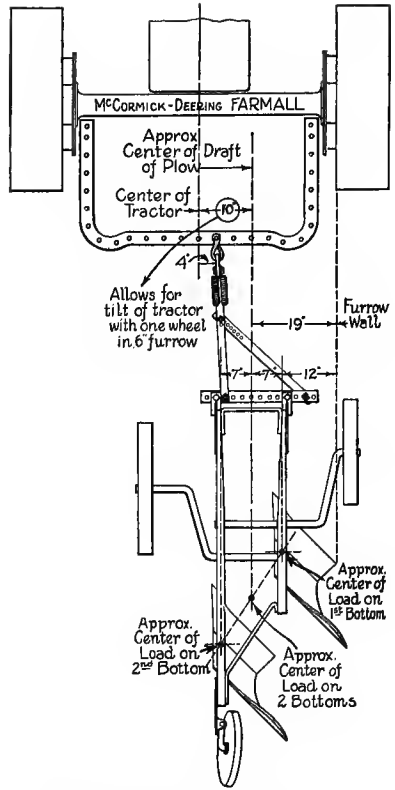

Illust. 36. Shows 2-bottom plow (14-inch bottoms) hitched to the Farmall.

carry the landside lightly in the bottom of the furrow. If the soil is allowed to pack on the wheel, the rear end of the plow is raised too high for good work.

We have tried in this article to cover the factors having most to do with quality and appearance of tractor plowing. Much that we have said applies to plowing with horses. Whereas, it requires an experienced plowman to do really first-class work with a horse plow, any man who can apply a few simple rules in setting his plow, and who can drive a tractor straight, can do first-class work with a tractor plow.



How to Sharpen a Steel Plow Share

Modern plow manufacturers have expended large sums of money for the purpose of giving the farmer the best plow shares that can be produced. Refrigerating plants have been installed to maintain the tempering bath at a uniform temperature; the best three-ply soft center steel that can be produced is used. In fact, nothing is left undone that will produce a plow share so hard that it will scour and polish like a mirror, yet withstand the strain and shock incident to heavy plowing; and all that has been accomplished along the lines above mentioned can be undone in a few minutes by the first man who sharpens the share, either through lack of knowledge, or carelessness.

The average blacksmith, after removing the share from the plow, plunges it into a big broad fire to heat, preparatory to sharpening, oft-times setting it on edge in the fire. This is wrong, as it permits the heat to extend over the entire surface of the share, withdrawing the hardness that the manufacturers were so careful to conserve. It also causes the share to warp and lose its original shape, causing annoyance in replacing the share on the plow.

To sharpen a plow share properly:

Build a fire on the forge suitable for this particular work. This is done by banking the fire, allowing only a small opening in the side for the blaze and heat to escape. Commence with the point of the share. Insert this into the fire just far enough to heat the part you wish to draw, never permitting the heat to extend farther back on the share than is absolutely necessary. Draw this down to the proper shape and thickness, which should be as near the original bevel as possible. After the point has been finished, work back toward the heel or wing of the share, never heating more than $1\frac{1}{2}$ inches from the edge and $2\frac{1}{2}$ inches wide. It is important to keep hammering after the steel has changed from a red heat to a black as this makes the edge tough and hard, giving a wearing surface that will last much longer.

If once down the share is not sufficient, reheat; but confine the heated part to the above measurements. In working along the cutting edge, keep it straight. In so doing you will avoid having to go back and reset the edge.

It is impossible to give the exact amount of wing bearing on walking plow shares, but it should be from 1 to $1\frac{3}{4}$ inches, according to the size of the plow. Shares used on wheel plows should have no wing bearing. These instructions refer to both hard and crucible steel shares.

Suction of Plow Shares

Worn Shares Waste Time, Money and Patience

It costs more to plow with worn shares, a great deal, than it does to sharpen them—it takes more power—it takes more time and results in excessive wear on the plow, particularly the wheel bearings if hitching high on the plow is resorted to to make the plow take to the ground, as it often is.

Bottom Suck

There is more to reconditioning a plow share than merely restoring the edge. If you will hold a yardstick under the bottom edge of the landside of a new plow, with the edge of the yardstick touching the point of the share and the heel of the landside, you will

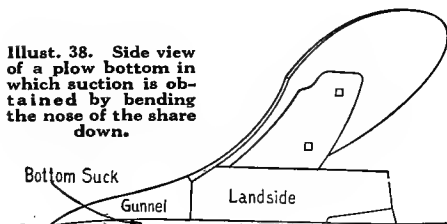

Illust. 38. Side view of a plow bottom in which suction is obtained by bending the nose of the share down.

note that at the point where the share joins the landside there is approximately one-half inch clearance. This is known as bottom, or down suck. It is the characteristic which makes the plow take to the ground. You can check the bottom suck in a bottom having a short landside by placing the bottom on a level surface and placing a half-inch block under the heel of the landside.

Too frequently when the shares begin to lose their suck and the plow begins to run out on the slightest provocation, the plowman tries to overcome the difficulty by raising the hitch on the plow. Now if you lay a rail over a block and push down on one end, the other end is bound to come up. That is just what happens when you hitch too high on the plow. The frame of the plow is the rail and the plow wheels are the block. The result of hitching too high is that while you do "throw the plow on its nose" you raise the heels of the landsides, you lose the steadying effect of the landsides, the plow has a tendency to kick to the left, and there is excessive wear on the front furrow and land wheel bearings.

Illust. 37. Side view of the plow bottom showing bottom suck. This is approximately $\frac{1}{4}$ inch on tractor and wheel bottoms. Notice that the under side of the gunnel is a straight line. The nose of this share should not be bent down by the blacksmith.

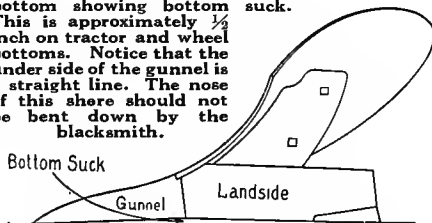

Two Types of Shares

In some plows bottom suck is secured by bending the nose of the share down after sharpening. This is usually accomplished by placing the share on an anvil, with the nose projecting over, and striking the nose with a hammer. In some plows, the bottom suck is determined by the angle of the share with relation to the bottom. In this type it is necessary merely to set the share on a faceplate after sharpening and bring the bottom edge of the landside portion of the share (gunnel or stub landside) to a straight line. It is very necessary, therefore, to know which type of share you are using, for if the latter type of share is given additional suction by bending the nose down, the additional penetration will more than likely result in a strong tendency of the plow to bury itself.

Side Suck

The nose of a new or properly reconditioned share also points slightly "toward the land." This characteristic is called side suck and is built into the share to make the bottom "hold its land;" that is, cut its proper width.

Reconditioning a share means sharpening and restoring the original bottom and side suck. Probably nine-tenths of the trouble which some folks have in making their plows work properly is due to worn shares. If your plow hesitates in taking to the ground, examine the shares to see if they have lost their bottom suck.

In reconditioning the share the point should be brought out to its original length.

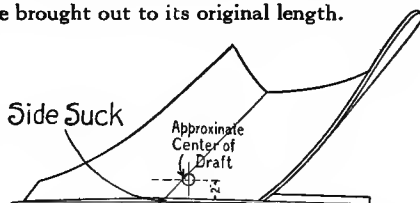

Illust. 39. Top view of a plow bottom showing side suck. The side suck varies from $\frac{1}{8}$ to $\frac{1}{4}$ inch in plow bottoms.

Methods for Laying Out Lands and Plowing With Tractors

In order that tractor users might receive the highest possible degree of satisfaction from their outfits, our publication *Tractor Farming*, published in the March issue of 1919, an article entitled "Plowing With Tractor Power." The accompanying illustrations and text are taken from that article. We hope this information will prove of benefit to those who receive this pamphlet.

Two Methods of Tractor Plowing

Broadly speaking, there are two distinct plans followed when plowing with a tractor. In one, the field is laid off in lands, to be plowed out in straight furrows. The plows are raised at each end of the field, headlands being left for turning. Headlands are plowed last. (See Illusts. 40 and 41.) It is customary to leave the same space on each side as is allowed for headlands, to permit plowing around the field when finishing, as shown in Illust. 41. If this is not done the headlands are plowed out as lands, either by back-furrowing or plowing them out to a dead furrow.

In the second plan the entire field is plowed by driving round and round without taking the plows from the ground at all, or for only a few feet, while turning corners. The outfit either

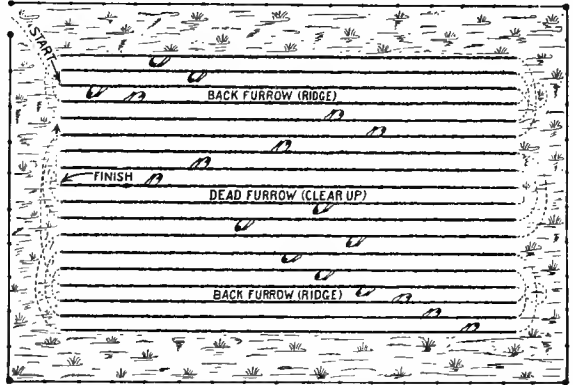

Illust. 40. Plowing the center of the field out in lands is the most common method. This shows one of the best plans for plowing out the lands in order to reduce idle running at the ends and eliminate about half the dead furrows. Plow symbols show direction dirt is thrown.

starts in the center of the field and works toward the outside, or starts at the outside and works toward the center. (See Illusts. 42 to 45 inclusive.)

The first plan, that of laying off the fields in lands, is by far the most common and some variation of it will probably be found most satisfactory on the average farm. The principal disadvantages of the system are that it involves considerable idle travel at the ends, and also leaves a number of dead or "clear-up" furrows. While there are some areas where the rainfall is heavy and the dead furrows are considered a desirable aid to drainage, in most sections dead furrows are more of a disadvantage than otherwise.

The majority of farmers, however, recommend some variation of this first general method, apparently considering that its advantages more than offset its disadvantages.

Nevertheless, unnecessary travel adds somewhat to cost and reduces the amount of plowing which can be done in a given time, and it should therefore be kept as low as practicable. The narrower the lands the less the amount of idle traveling required, but the greater the number of dead furrows. There is a simple plan of

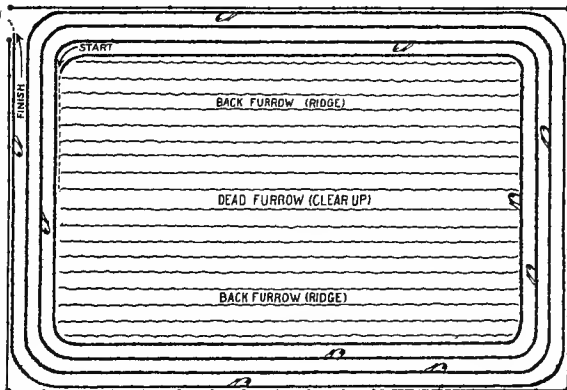

Illust. 41. Most farmers leave the same space at the sides of the field as at the ends and then plow round the entire field in finishing up. If desired, the entire width may be plowed in lands and the headlands plowed out separately as individual lands.

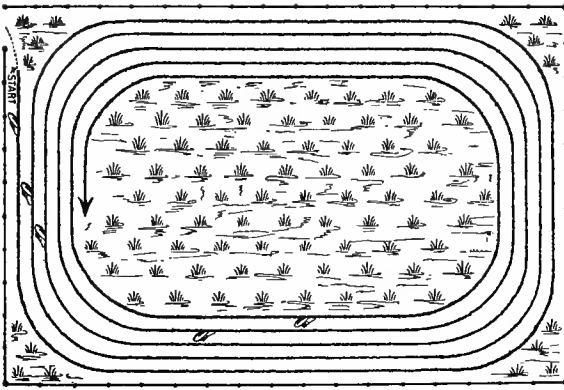

Illust. 42. Plowing round and round, turning to the left and throwing the soil toward the fence without raising the plows from the ground. Note the wider furrows at corners which means poorer plowing, but this method eliminates all idle running.

plowing out lands, however, which will reduce the number of dead furrows by approximately one-half without increasing the size of the lands or the amount of idle travel, and every farmer who plows in lands should be acquainted with this method.

Reduce Dead Furrows Without Additional Idle Travel

This scheme consists of plowing out alternate lands by back-furrowing (in some parts of the East this is known as "striking a ridge" and plowing around it), and then plowing round each intermediate land to a dead furrow. In other words, every odd land (first, third, fifth, etc.) will be plowed round by turning to the right, throwing the soil to the center, while every even land (second, fourth, sixth, etc.) will be plowed out by driving round it, turning to the left, throwing the dirt toward the sides of the land, and finishing in the center, leaving a dead furrow. When following this plan the first and third lands are completed before starting the second, and the fifth land is plowed before starting on land four, and so on. Illust. 40 shows this method of plowing out a field of three lands. As in all the illustrations, no attempt was made to draw furrows even approximately to scale—the lines merely indicate the line of travel of the tractor, and the direction.

By following this plan a field in which there are only three lands will have but one dead furrow,

instead of two which would result from plowing each land out by back-furrowing. A field laid off in five lands will have but two dead furrows instead of four.

It pays to take care in laying off the lands, since inaccuracy of locating the lands or insufficient markings cause considerable inconvenience when finishing up the work, at the same time spoiling the looks of the work. Very often the work of laying off and marking the field for plowing can be done at odd times—in fact, several weeks before the work is started. It pays to use plenty of markers—it doesn't take much longer, may save a lot of time in finishing, and is almost sure to result in better work. It is much easier to plow a straight furrow by

keeping markers in line than driving toward a single marker at the other end of the field.

The accuracy of laying off the field can be increased by constructing a measuring frame of light strips of wood in the shape of a letter "A" with the lower points the exact widths of the strip turned by the gang plow or some multiple of this width. The use of this device will usually make it possible to finish it up evenly without having to plow extra furrows.

When a field is to be plowed in lands it is always advisable to have a mark at each end, as a guide for raising and lowering the plows. This mark can be a single furrow plowed at each end of the field. These furrows should be as shallow as possible to avoid jolting the tractor and plow when driving across them and the furrows should be thrown in toward the center of the field. A mere scratch parallel with the fence or boundary of the field is all that is required.

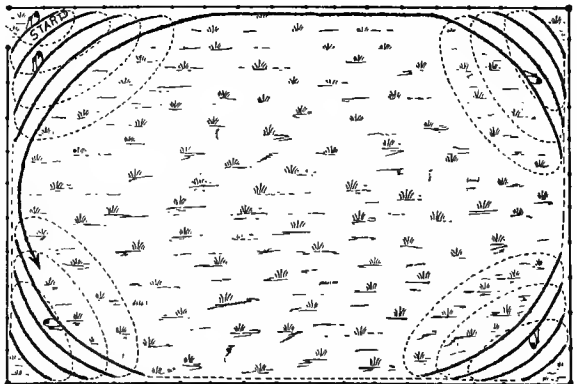

Illust. 43. Showing how some farmers plow out the corners first when they wish to plow round and round the field in the manner shown in Illust. 42. This permits all the work to be done with the tractor and makes a gradual curve for turning.

Plowing Round and Round

The system of plowing round and round the field without taking the plows from the ground, or for only a few feet at the corners, has the advantage of greater speed and a minimum of idle travel. The principal objection is the quality of the work at the corners. If the plows are left in the ground all the way around the work done on the turns will not be first class unless a very wide curve is made, and a wide curve leaves more unplowed land in the corners.

Turning to the Right

If the curve at the corner is very gradual the tendency to cut wide or "cut and cover" is not so pronounced and may be entirely unobjectionable.

When turning to the right the bottoms will not cut full furrows and therefore will not do a really first-class piece of work, although the quality will not be lowered so greatly as when turning to the left. In a large field, however, it will result in leaving considerable ground in the corners by the time the furrows on the ends and sides have reached the fence. In order to avoid leaving a considerable amount of unplowed land at the corners, therefore, extra furrows should be plowed at the corners to bring them out even. This should be done as near the end of the job as possible when there is just room enough left for turning on the unplowed land, and then plowing enough extra furrows around the curve at each corner to bring the corners practically the same dis-

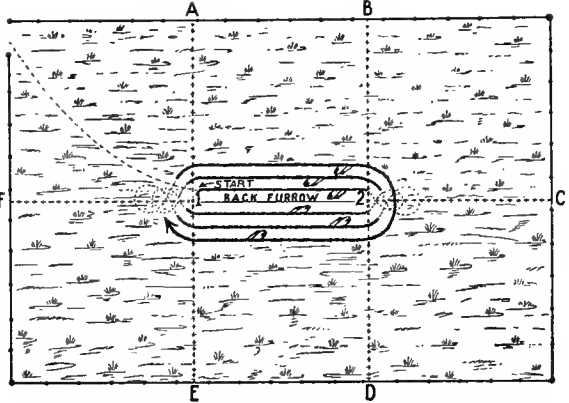

Illust. 44. A method commonly used alternately with that shown in Illust. 33. Find point marked "1," equally distant from A, F and E, and point 2, equally distant from B, C and D. Back-furrow between 1 and 2 for a few rounds, then plow round and round.

tance from the fence as the side and end furrows. By again plowing round and round the entire field it will then be possible to plow out practically every foot of the field with the tractor outfit.

Turning to the Left

When plowing round and round, making left turns, throwing the soil toward the fence, the curve should be gradual at the corners so as to avoid having to run the tractor off the land or into the plowed land in order to make the turn without the furrow wheel of the plow leaving the furrow. To do this the corners should be plowed out first until a wide curve has been made, as shown in Illust. 43. The field can then be furnished by plowing round and round, and practically every foot can be plowed with the tractor.

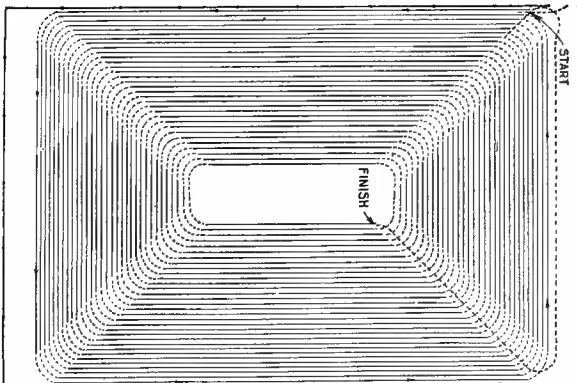

Illust. 45. A variation of method shown in Illust. 42. Plows raised at corners while turning. All furrows are kept straight and idle travel considerably reduced. When point marked "Finish" is reached, the unplowed land is plowed out as shown in Illust. 46.

A variation of the plan of plowing round and round the field is shown in Illust. 45. As can be seen, the field is plowed round and round with the plows raised at each corner while a half-turn is being made, but instead of plowing close to the fence on all four sides of the field a headland is left at the two ends, the same width as the strip between the ends of the furrows where the plows are taken out in turning. When the unplowed land in the center of the field is twice the width of these headlands and corner strips, the corners and headlands are plowed out by driving round and round, as shown in Illust. 44. This avoids making

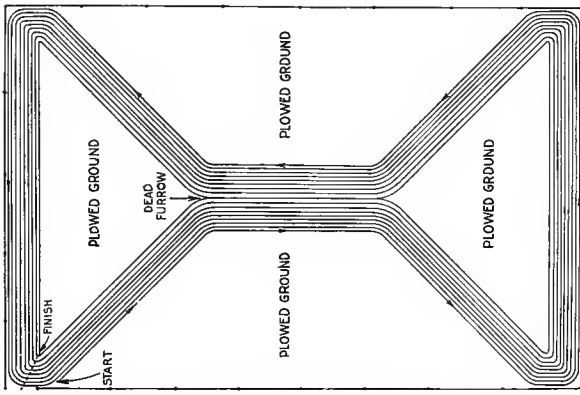

Illust. 46. Method of finishing a land plowed as shown in Illust. 45. This shows the ends, corners and center plowed round and round to a dead furrow in the center, starting the finishing furrows at the point marked "start." If desired, it can be plowed out by back-furrowing.

short turns in the corners of the field, which are necessary in case the headlands are not left.

This plan permits the entire field to be plowed with the tractor just as close in the corners as the tractor can go, and that is about as close as it can be done with horses. While the method is best suited for plowing with left-hand turns, that is, throwing the furrows toward the fence, it can be used very satisfactorily for throwing the soil toward the center of the field, if the field is carefully measured off so as to permit starting at the proper points at the center.

Don't Plow Same Way Every Year

Most plowmen like to throw the soil toward the fence one year and toward the land the next. This can easily be accomplished by either of the two general methods of plowing described. If the center of the field is plowed out in lands the headlands and the strips on each side can be plowed out by driving around the field either to the right or to the left. When the method of plowing round and round is used this can be alternated by starting at the fence and turning to the left one year and beginning at the center and plowing round and round to the right the next, whether the plows are left in the ground all the time or raised in the corners.

Irregular Fields

Most fields of irregular shape can be plowed using either of the two general methods described by exercising a little thought in adapting them. Plowing round and round,

making left turns, will probably be as satisfactory as any method for the first time. Plows can either be raised at the corners or left in the ground, as desired. By making some sort of a mark at the center of the field as located by this method of plowing, the next time the field is plowed the work can be started at these points. If the field is plowed out to a dead-furrow, this furrow can usually be located and used as a guide for starting plowing and turning to the right. Plowing in lands can usually be followed to good advantage in fields having two parallel sides by laying off the lands parallel with the parallel sides and

raising the plows at the ends equally distant from the fence at all points.

Plowing Round and Round Turning Square Corners

Illust. 47 shows a method occasionally used but involving a large number of turns with the plow idle. It is used by some plowmen alternately with the methods shown in Illusts. 42 to 45. The quality of the plowing compares very favorably with that done by any other method.

As can be seen in the illustration, the center of the field is located as in Illust. 44 and the land started by back-furrowing. After the land is several feet wide, furrows are plowed across the end at each round, complete turns being made at the four corners by looping to the left. When there is no longer room left for turning at the corners, the remaining strip can be plowed out as shown in Illust. 41.

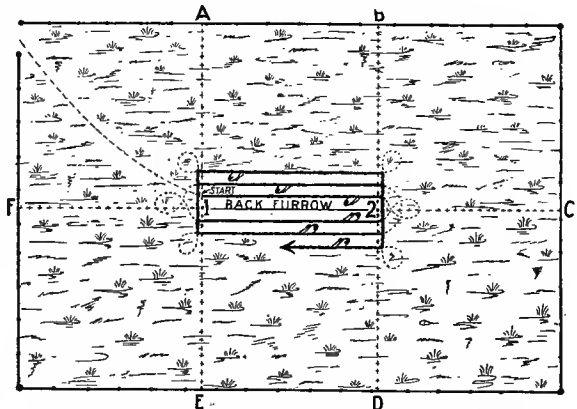

Illust. 47. Method sometimes practiced alternately with that shown in Illust. 45. Points 1 and 2 located as in Illust. 44 and a land back-furrowed a few rounds after which furrows are plowed across ends, complete turn made at corners by looping to left.

McCormick-Deering Triple-Power Tractors

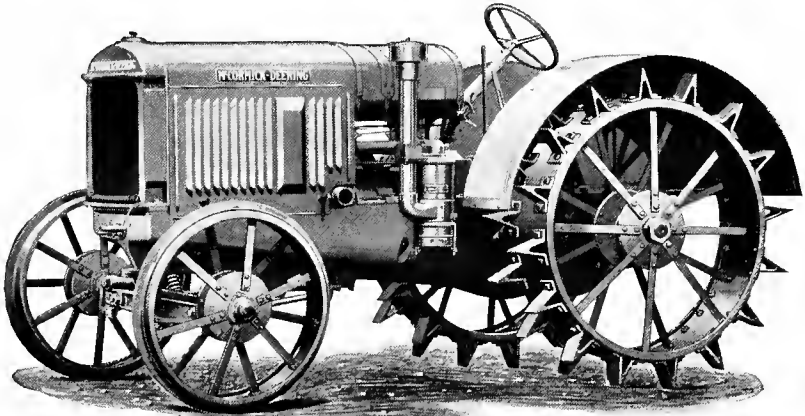

Illust. 48. The McCormick-Deering 15-30—a powerful tractor for big-scale farming.

The McCormick-Deering 10-20 and 15-30 tractors have an abundance of dependable power for the heavy plowing and seed-bed preparation jobs. They pull large-scale harvesting equipment and operate the many belt-driven machines.

This low-cost, heavy-duty power places all farming operations on an efficient, low-cost basis. Equally as important as disposing of the heavy work is the ability of these tractors to keep all farm operations on schedule, overcoming weather delays and other handicaps that may occur.

These tractors are McCormick-Deering con-

struction from radiator to drawbar and are popular because of many distinctive features. Included among these are removable cylinders, factory-sealed governor, combination manifold for using either kerosene or gasoline, oil filter, air cleaner, one-piece main frame, and unit construction. The unit construction feature is invaluable in tractor design. Any unit—engine, clutch, transmission, final drive, etc.—can be removed without disturbing the adjacent units. Three forward speeds of approximately 2, 3, and 4 miles per hour meet all working conditions, whether in the field or on the road.



Illust. 49. McCormick-Deering 10-20 tractor doing a good job of plowing and harrowing in one operation at low cost.

McCormick-Deering TracTracTors

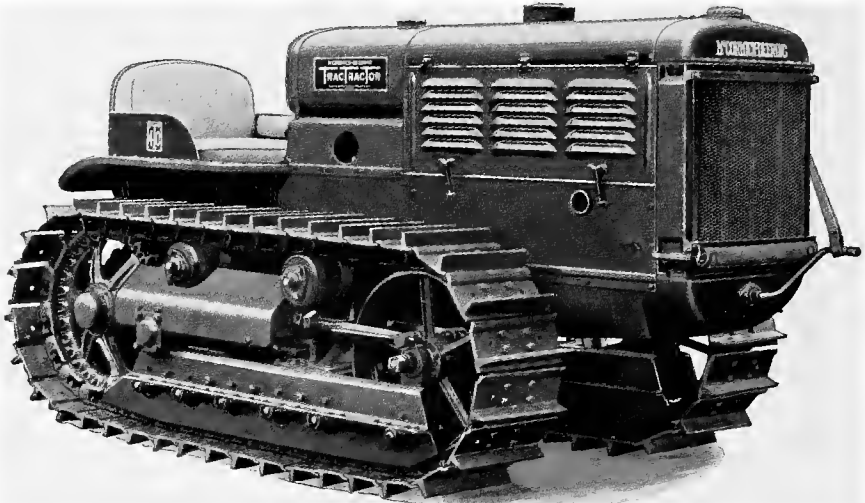

Illust. 50. McCormick-Deering T-40 TracTracTor. The T-20 is similar in design.

The McCormick-Deering TracTracTors—Model T-20 and Model T-40—are the crawler-type members of the McCormick-Deering tractor family. They are the most accessible crawler tractors built. The rugged construction, combined with proved engineering practices and modern alloy steels, assures crawler tractors that meet McCormick-Deering standards of performance, economy, and durability. Their conveniently located controls and the upholstered cushion seats are features which contribute to the comfort of the operator and result in a bigger and better day's work.

McCormick-Deering TracTracTors are compact units which operate in close quarters. The T-20 is especially adapted to working under low-hanging trees, in orchards, and similar work. More than forty ball bearings assist in providing an unusual degree of transmitted power in the TracTracTors. The steering clutches and steering brakes located in the rear compartment of the main frame introduce an innovation in efficient steering performance for track-type tractors. Wherever the going is uncertain, the load heavy, and the work difficult, TracTracTors will do the job.

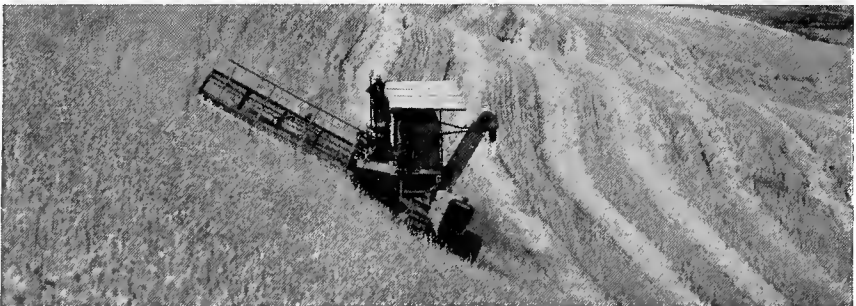

Illust. 51. The T-40 delivers the power required on the Northwest hillsides.

The Famous FARMALL Now in Three Sizes

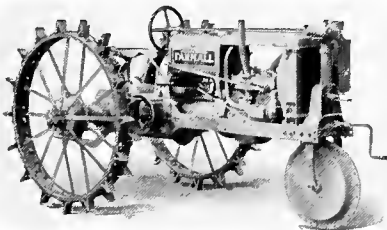

Illust. 52. Farmall 12.

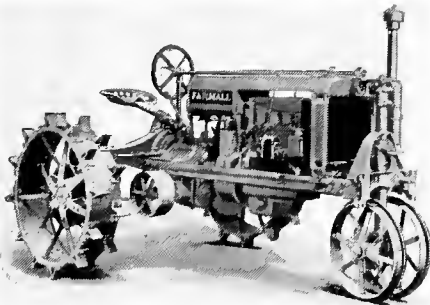

Illust. 53. The regular Farmall, the original successful row-crop all-purpose tractor.

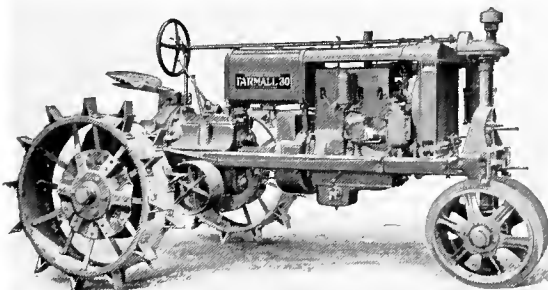

Illust. 54. Farmall 30, the 3-plow size of the famous Farmall.

The regular FARMALL, the original row-crop, all-purpose, two-plow tractor, meets the requirements of the average farm. It pulls two 14-inch bottoms, wide tillage tools, two and four-row cultivators, four-row planters, etc. Broadly, the regular FARMALL fits the farms in the quarter-section class. It supplies fast, economical, dependable power for all field and belt operations. It also provides power through the power take-off for corn pickers, binders, potato diggers, etc.

The FARMALL-30 is the three-plow size. It meets the power requirements of the farms in the 200 to 300-acre class, where the power demand is heavier, due to unusual soil conditions, or larger tillage combinations. It supplies ample power for two-row corn pickers, two-row potato diggers, harvester-threshers, etc. It is a handy tractor for the row-crop farm, and a husky, versatile tractor for any farm.

FARMALL 12, the newest member of the famous FARMALL line, is the tractor for the smaller row-crop, or the very small intensively worked farms. It pulls one 16-inch, or two 10-inch bottoms, and tillage tools of like drawbar demand. Already it has made a name for itself as a two-row

cultivating tractor, and many tractor users operating larger tractors are buying the FARMALL-12 for use as an auxiliary tractor. A gallon of gasoline an hour or a little over, is all the F-12 needs on the average job, which makes it a wonderfully economical tractor on all drawbar and belt work within its capacity range.

For further information on these famous row-crop, all-purpose, triple-power tractors, see the nearest McCormick-Deering dealer, or write for special catalog.



Operating a two-row middle buster.



Cultivating two rows.



Well adapted for farm work.

McCormick - Deering Tractor Plows

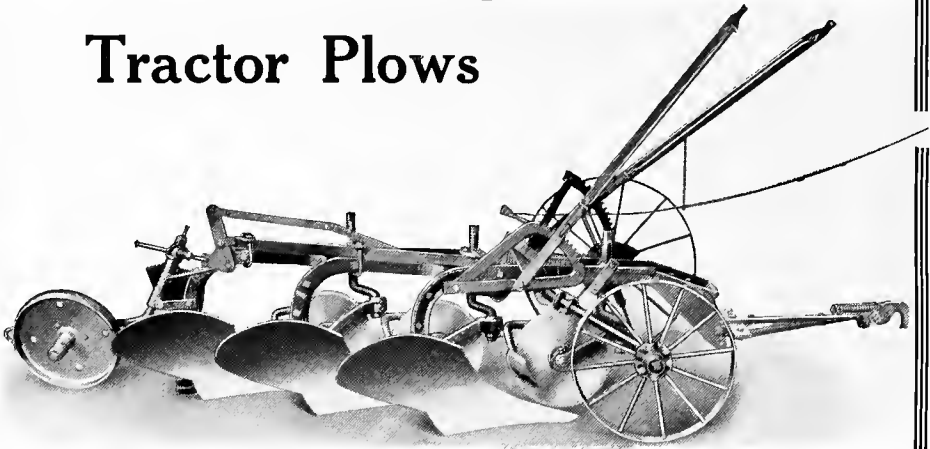

Illust. 55. McCormick-Deering No. 8 Little Genius tractor plow.

MCCORMICK-DEERING tractor moldboard plows are notable for the ease with which they can be adapted to varying soil conditions and for their remarkable stamina in extremely hard plowing.

The line includes the No. 8 Little Genius in 2 and 3-furrow with 10, 12, 14, or 16-inch bottoms and 4-furrow with 14-inch bottoms.

The bottoms are the product of nearly 90 years of plow building experience. There is a bottom for every soil. The shares are quick-detachable.

The Little Genius can be supplied with special equipment in the way of wide tires for loose or sandy soils, special coulter, jointers, knife cutters, etc.—whatever is needed to adapt the

Little Genius to plowing conditions anywhere.

The Little Wonder is a two-bottom two-wheel tractor plow for small tractors. It is as light in weight as it is possible to build a good plow. The same types of bottoms are available as for the Little Genius, in 12 and 14-inch sizes.

The line also includes the Little Genius in one and two furrow with 18-inch bottoms, and special breaking plows. Whatever your plow requirements, there is a plow in the McCormick-Deering line that will meet them.

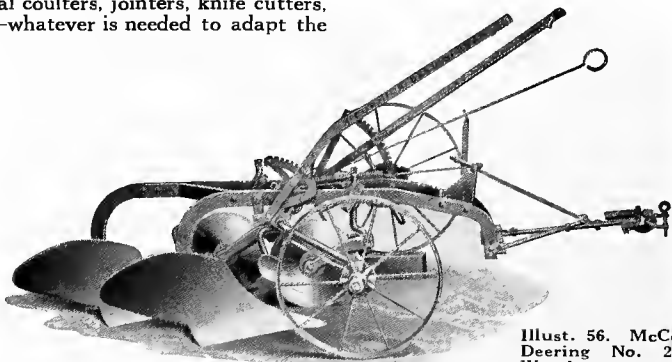

Illust. 56. McCormick-Deering No. 2nd Little Wonder tractor plow for small tractors.

McCormick-Deering

Tractor Disk Plows

THE two leaders in the McCormick-Deering line of disk plows are the Nos. 33 and 34. These plows are more than the leaders of a line—they set a new standard for disk plow efficiency. No. 33 is probably the heaviest disk plow of its type ever built. It was built to meet conditions as they are found, for instance, in the Imperial Valley and in the Salt River Valley.

Several new features embodied in the No. 33 were so popular as to lead to an immediate demand for a disk plow of similar design but lighter in weight and adapted to general conditions. The No. 34 is the answer to that demand.

The dream of plow designers, since the idea of a disk plow was first conceived, has been to build a plow that would stick to its work under all conditions. Nos. 33 and 34 are that kind of plows.

No. 33 is supplied in 3, 4, and 5-furrow sizes and regularly equipped with 26-inch disks. No. 34 is supplied in 2, 3, 4, 5, and 6-furrow sizes, with 26-inch disks. These plows are equipped to meet usual conditions, and a wide range of special equipment is available to adapt them to extreme conditions.

If you would like to know more about these remarkable disk plows, ask for the McCormick-Deering Tractor Plow Catalog.

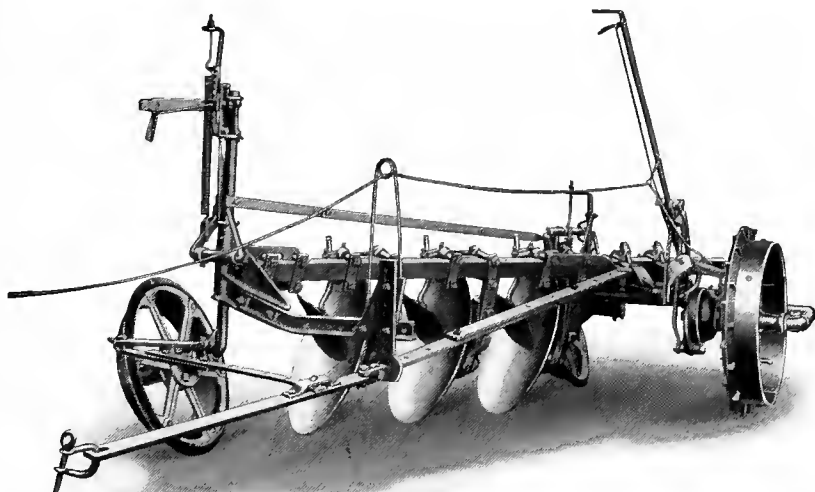

Illust. 57. A front view of the 34-3 tractor disk plow.

McCormick-Deering Line

PLOWS (All Types). McCormick-Deering Walking Plows and Middle Breakers, steel and chilled. Two, three and four-furrow moldboard and disk Tractor Plows. Sulky and gang, moldboard and disk Riding Plows. Farmall Plows. Orchard and Vineyard Plows. Harrow-Plows. Special plows for every purpose.



TILLAGE IMPLEMENTS (All Types). McCormick-Deering Disk Harrows, seven sizes, with or without tandem. Special orchard disk, and reversible types. Tractor Disk Harrows, Offset Disk Harrows, Spring-Tooth Harrows, Peg-Tooth Harrows, One-Horse Cultivators with 5, 7 and 9 shovels, also 7, 9 and 14 teeth. Ridge Busters, for horses or tractors. Rotary Hoes, Soil Pulverizers, Field Cultivators, Rod Weeders, Land Packers and Plow Packers.

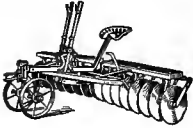

KEROSENE ENGINES. McCormick-Deering, operate on kerosene as well as gasoline. Sizes 1½, 3, 6 and 10 horsepower. Hopper-cooled. All have throttling governors, serviceable magnets, removable cylinders and enclosed crankcases. Friction clutch and plain pulleys. Hand and horse trucks extra. McCormick-Deering 4-Cylinder Industrial Power Units.

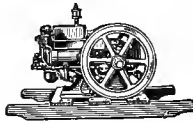

TRACTORS. McCormick-Deering, sizes 10-20 and 15-30. Also Industrial Tractors with rubber tires. Power Take-Off for tractor binder, coilage harvester, corn picker, rice binder, etc. Tractor Hitcher for all drawbar machines.

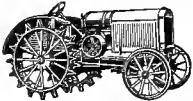

FARMALL TRACTORS. McCormick-Deering, 2- and 3-plov sizes, operate on kerosene or gasoline. Also F-12, the new Farmall for smaller farms. Fast, economical power for seed-bed work, planting and cultivating row crops, haying, harvest, and belt work. Special Farmall machines.

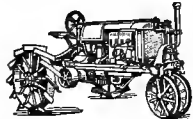

TRACTORS McCormick-Deering T-20 and Six-Cylinder T-40 for farm, highway and industrial work. Rugged construction; compact, powerful engines, convenient controls, a variety of speeds to meet all requirements.

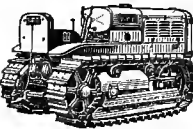

MOTOR TRUCKS. International Motor Trucks, ½ to 7½-ton capacities including the famous 1½-ton Six-Speed Special. Also 6-cylinder speed trucks in ½, 1½, 2, and 3-ton sizes and heavy-duty, double reduction gear-drive models in 3 to 7½-ton capacities. Suitable bodies for all hauling purposes.



THRESHERS. McCormick-Deering, 22 x 38 and 28 x 46. Ball-bearing cylinders. Roller bearing stacker fan. Can be equipped with self-feeders, wind stackers, grain measuring elevators and loaders. Pea, Bean, Rice, Alfalfa and Clover Threshers.

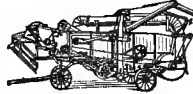

CREAM SEPARATORS. McCormick-Deering Ball-Bearing Separators turn easily, skim closely, and are easy to keep clean. Hand, engine, and electric driven types. Capacities, 350, 500, 750, 900, 1200 and 1500 pounds of milk per hour. McCormick-Deering Cream Separator Oil, a specially prepared light-bodied lubricant for cream separators.



MILKERS. McCormick-Deering Milkers, single and double units, single and double cylinder vacuum pumps, engine and motor drive; efficient and sanitary, with many new and patented features. No-oil, no-spring pulsator assures satisfactory performance in hot and cold weather.



CANE MILLS. McCormick-Deering. Powerful three-roll mills that "get the juice." Upright, horsepower mills in four sizes, capacities from 35 to 90 gallons of juice per hour. Belt power mills, three-roll, horizontal, capacities 175 to 250 gallons per hour. Juice pumps.

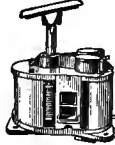

GRAIN DRILLS AND LIME SOWERS. McCormick-Deering Grain Drills; sizes 5 to 57-furrow openers; 4, 6, 7 and 8-inch spacing. Press drills and press wheel attachments. Also fertilizer drills, beet drills, alfalfa drills, one-horse, endgate and broadcast seeders. McCormick-Deering Lime Sowers, Endgate Lime Spreaders, Fertilizer Distributors and Crop Dusters.

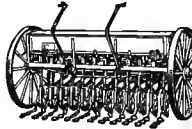

MANURE SPREADERS. McCormick-Deering, horse-drawn, 60 to 70 bu. capacity; eight roller bearings, six conveyor speeds. McCormick-Deering Power Spreader, 130 to 150 bu. capacity; entire mechanism operated by tractor power transmitted through the power take-off.



STALK CUTTERS. McCormick-Deering. Single row 7 or 9 blades. Has steel wheels, non-clogging knife head, angle steel frame, dust-proof bearings, shock absorbing hitch. Two-row, 14-knife. Separate cutting cylinder for each row. The cutting cylinders on these stalk cutters are spring suspended, greatly reducing vibration.

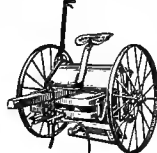

"Good equipment makes a good farmer better"

McCormick-Deering Line

GRAIN BINDERS, REAPERS, TWINE. McCormick-Deering Binders, 6, 7 and 8-foot cut. Special binders for rice. McCormick-Deering Tractor Binder, 10-foot cut. McCormick-Deering Reapers in 5 and 5½-foot cut.

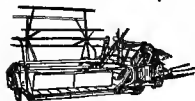

HARVESTER-THRESHERS, WINDROW HARVESTERS, HEADERS, PUSH BINDERS. McCormick-Deering Harvester-Threshers. Four styles, 8, 10, 12 and 16-foot prairie types and 12-foot hillsides type. A 4-foot extension supplied for hillsides type, making 16-foot cut. Harvest and thresh small grains, soybeans and other crops in one operation. McCormick-Deering Windrow Harvesters, 8, 12 and 16-foot. McCormick-Deering Headers, 12 and 14-foot. Push Binders, 10, 12 and 14-foot cuts.

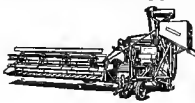

MOWERS AND KNIFE GRINDERS. McCormick-Deering Mowers, 1-horse 3½-foot vertical lift; 2-horse regular and vertical lift, 4½ and 5-foot cuts. Heavy-duty types, 4½ and 5-foot, regular and vertical lift, 6 and 7-foot regular lift only. Rubber-tired highway mowers. Trailing mower for tractor. Special Farmall and tractor mowers. McCormick-Deering Knife Grinders for mower knives. Tool and saw gumming wheels extra. McCormick-Deering Shredder Knife-Haad Grinder.

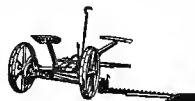

RAKES (All Types) TEDDERS. McCormick-Deering Self-Dump Rakes, 8, 9, 10 and 12-foot; cornstalk rake, 11-foot. McCormick-Deering Sweep Rakes, three styles. McCormick-Deering Side Rakes and Tedders, 7½ and 8-foot sizes. McCormick-Deering Tedders, 6 and 8-foot.



HAY LOADERS AND STACKERS. McCormick-Deering Windrow Loader, 6-foot. Double Cylinder Loader, Cylinder-Rake Loader, 6-foot. All hitch from topload. McCormick-Deering Stackers, two types, overshot and special high lift.



HAY PRESSES. McCormick-Deering one and two-horse type and power presses. Three sizes, 14x18, 16x18 and 17x22 bales. Power presses run either by tractor or engine.



PLANTERS AND LISTERS. McCormick-Deering Corr. Planters, 100 Series, checkrow, drill and hill-drop drill, flat, edge- or full-hill-drop plates. McCormick-Deering Cotton and Corn Planters, walking and riding, single and two-row. Fertilizer attachments. Horse and Tractor Listers, corn, cotton and corn, and Wheatland.

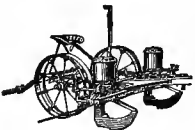

BEEB IMPLEMENTS. McCormick-Deering plain and fertilizer Beat Drills. McCormick-Deering two and four-row Beat Cultivators. Riding Beat Pullers.



POTATO PLANTERS AND DIGGERS. McCormick-Deering one and two-row Potato Planters, picker-wheel type, plain and fertilizer. Two and four-horse Potato Diggers, elevator type, rod-link and bar-grate. Walking Diggers. Farmall Power Drive Diggers, 1 and 2-row.



CULTIVATORS. McCormick-Deering, for all crops. One and two-row, riding or walking, disk and surface cultivators. All varieties of shovels and gangs. Lister Cultivators, single row, sled and wheeled. Two and three-row wheeled. Field Cultivators, 6, 7½, 9 and 12-foot sizes.



CORN BINDERS AND PICKERS. McCormick-Deering Corn Binders, vertical and horizontal. Special type for short corn. McCormick-Deering Corn Pickers, 1 and 2-row, Farmall and pull type.

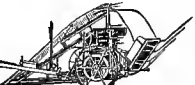

ENSILAGE CUTTERS. McCormick-Deering, four sizes with capacity of 3 to 25 tons cut ensilage per hour. Force feed, large throat and boiler plate steel flywheel. Six to 25 horsepower required. McCormick-Deering Ronging Ensilage Harvester and McCormick-Deering Ensilage Blower.

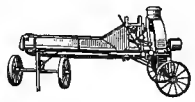

HUSKERS AND SHREDDERS. McCormick-Deering Steel Husker and Shredder. Large capacity, all-steel construction, combined snapping and husking rolls, all moving parts protected by shields, large and convenient feed tables.



CORN SHELLERS AND FEED MILLS. McCormick-Deering Shellers. Spring type, hand or power, mounted or down, 4 sizes. Cylinder Shellers, 2 sizes. McCormick-Deering Feed Grinders, 3 types in various capacities. McCormick-Deering Hammer Mills.



FARM WAGONS AND TRUCKS. Waber Wagons; Keystone and Monarch Trucks; standard and wide track. One-horse wagons. McCormick-Deering All-Purpose all-steel, roller-bearing Truck. Wagon Boxes.



SOIL PULVERIZERS. Double Gang. Two machines in one. Cultivates the soil and crushes lumps. Finishes what other tillage tools begin. Made in eight widths for horse or tractor power. Also single gang soil pulverizers.

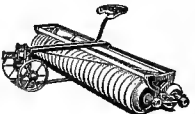

BINDER TWINE. McCormick-Deering and International. Standard and Sisal, 500 ft. per lb. Manila, 600 and 650 ft. per lb. Six 8-lb. balls to the bale. Guaranteed for length, strength and weight. Treated against destruction by insects.



McCormick-Deering Service

Eighty-seven IHC Branches Assure Unusual After-Sale Service

The Harvester Company believes that every purchaser of a machine is entitled to two kinds of service—service from the machine itself and service from the organization back of it.

In keeping with that policy, a nation-wide network of eighty-seven Company-owned branches, working in conjunction with the thousands of McCormick-Deering dealers, provides prompt service for every owner of McCormick-Deering machines.

IHC Branches Are Located in the Following Cities

Aberdeen, S. D.	Des Moines, Iowa	Lincoln, Nebr.	Richmond, Va.
Albany, N. Y.	Dodge City, Kans.	Little Rock, Ark.	Saginaw, Mich.
Amarillo, Texas	Dubuque, Iowa	Los Angeles, Calif.	St. Cloud, Minn.
Atlanta, Ga.	Eau Claire, Wis.	Louisville, Ky.	St. Joseph, Mo.
Auburn, N. Y.	Elmira, N. Y.	Madison, Wis.	St. Louis, Mo.
Aurora, Ill.	Evansville, Ind.	Mankato, Minn.	Salina, Kans.
Baltimore, Md.	Fargo, N. D.	Mason City, Iowa	Salt Lake City, Utah
Billings, Mont.	Fort Dodge, Iowa	Memphis, Tenn.	San Antonio, Texas
Birmingham, Ala.	Fort Wayne, Ind.	Milwaukee, Wis.	San Francisco, Calif.
Bismarck, N. D.	Grand Forks, N. D.	Minneapolis, Minn.	Shreveport, La.
Boston, Mass.	Grand Island, Nebr.	Minot, N. D.	Sioux City, Iowa
Buffalo, N. Y.	Grand Rapids, Mich.	Nashville, Tenn.	Sioux Falls, S. D.
Charlotte, N. C.	Great Falls, Mont.	New Orleans, La.	Spokane, Wash.
Cheyenne, Wyo.	Green Bay, Wis.	New York, N. Y.	Springfield, Ill.
Chicago, Ill.	Harrisburg, Pa.	Oklahoma City, Okla.	Springfield, Mo.
Cincinnati, Ohio	Houston, Texas	Omaha, Nebr.	Sweetwater, Texas
Cleveland, Ohio	Hutchinson, Kans.	Parkersburg, W. Va.	Terre Haute, Ind.
Columbus, Ohio	Indianapolis, Ind.	Peoria, Ill.	Toledo, Ohio
Council Bluffs, Iowa	Jackson, Mich.	Philadelphia, Pa.	Topeka, Kans.
Dallas, Texas	Jacksonville, Fla.	Pittsburgh, Pa.	Watertown, S. D.
Davenport, Iowa	Kankakee, Ill.	Portland, Ore.	Wichita, Kans.
Denver, Colo.	Kansas City, Mo.	Quincy, Ill.	

The Farther You Go From One, the Nearer You Get To Another

INTERNATIONAL HARVESTER COMPANY

OF AMERICA

606 SO. MICHIGAN AVE.

(INCORPORATED)

CHICAGO, ILL.

"Good equipment makes a good farmer better"

